

# DAY TWENTY ONE

# Unit Test 4

## (Electrostatics and Current Electricity)

1 In given figure,  $E$  is equal to

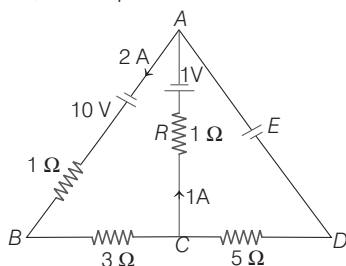

- (a) 1 V  
(b) 3 V  
(c) 2.5 V  
(d) None of these

2 In given figure, potential difference across  $5\ \Omega$  resistor is nearly

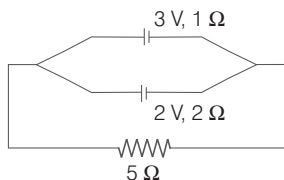

- (a) 2.4 V  
(b) 5 V  
(c) 4 V  
(d) 6 V

3 In the bridge as shown in figure, current through the galvanometer will be zero when the value of  $x$  is

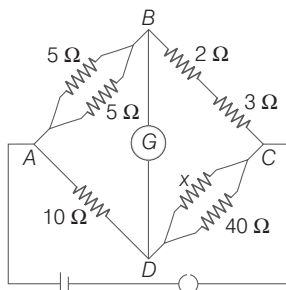

- (a)  $10\ \Omega$   
(b)  $20\ \Omega$   
(c)  $40\ \Omega$   
(d)  $5\ \Omega$

4 A conducting loop has a charge of  $q = 4\ \mu\text{C}$ . The thickness of the loop is negligible and its radius is  $r = 6\ \text{cm}$ . What is the electric field ( $E$ ) on the axis of symmetry of the loop at a distance of  $x = 8\ \text{cm}$  from the centre of the loop?

- (a)  $288 \times 10^2\ \text{Vm}^{-1}$   
(b)  $288 \times 10^3\ \text{Vm}^{-1}$   
(c)  $288 \times 10^4\ \text{Vm}^{-1}$   
(d)  $288 \times 10^5\ \text{Vm}^{-1}$

5 Eight dipoles of charges of magnitude  $e$  are placed inside a cube. The total electric flux coming out of the cube will be

- (a)  $\frac{8e}{\epsilon_0}$   
(b)  $\frac{16e}{\epsilon_0}$   
(c)  $\frac{e}{\epsilon_0}$   
(d) zero

6 Consider a current carrying wire (current  $I$ ) in the shape of a circle. Note that as the current progresses along the wire, the direction of  $\mathbf{J}$  (current density) changes in an exact manner, while the current  $I$  remains unaffected.

The agent that is essentially responsible for is

- (a) source of emf  
(b) electric field produced by charges accumulated on the surface of wire  
(c) the charges just behind a given segment of wire which push them just the right way by repulsion  
(d) the charge ahead

7 Two conductors  $A$  and  $B$  of the same length and radius are connected across the same battery. Resistivity of  $A$  is twice that of  $B$ . If  $P_A$  and  $P_B$  be the powers dissipated across  $A$  and  $B$  respectively, then

- (a)  $P_A = P_B$   
(b)  $P_A > P_B$   
(c)  $P_A < P_B$   
(d) None of these



- 8** Electric potential at any point  $V = -5x + 3y + \sqrt{15}z$ , then the magnitude of the electric field is  
 (a)  $3\sqrt{2}$  (b)  $4\sqrt{2}$  (c)  $5\sqrt{2}$  (d) 7
- 9** Eight mercury droplets having a radius of 1 mm and a charge of 0.066 pC each merge to have one droplet. Its potential is  
 (a) 2.4 V (b) 1.2 V (c) 3.6 V (d) 4.8 V
- 10** A charged sphere of diameter 4 cm has a charge density of  $10^{-4} \text{ C cm}^{-3}$ . The work done in joule when a charge of 40 nC is moved from infinity to a point which is at a distance of 2 cm from the surface of the sphere is  
 (a)  $14.4 \pi$  (b)  $28.8 \pi$   
 (c) 144  $\pi$  (d) 288  $\pi$
- 11** A current of 1.5 A flows through a copper voltmeter. The thickness of copper deposited on the electrode surface of area  $50 \text{ cm}^2$  in 20 min will be (Density of copper =  $9000 \text{ kgm}^{-3}$  and ECE of copper =  $0.00033 \text{ g C}^{-1}$ )  
 (a)  $2.6 \times 10^{-5} \text{ m}$  (b)  $2.6 \times 10^{-4} \text{ m}$   
 (c)  $1.3 \times 10^{-5} \text{ m}$  (d)  $1.3 \times 10^{-4} \text{ m}$
- 12** A charge  $Q$  is distributed over two concentric hollow spheres of radii  $r$  and  $R$  ( $R > r$ ) such that, their surface densities are equal. Find the potential at the common centre  $k = (4\pi\epsilon_0)^{-1}$ .  
 (a)  $\frac{kQ}{R+r}$  (b)  $\frac{kQ(R+r)}{(R^2+r^2)}$   
 (c)  $\frac{kQ}{r}$  (d)  $\frac{kQ}{R}$
- 13** A charged particle  $q$  is shot towards another charged particle  $Q$ , which is fixed, with a speed  $v$ . It approaches  $Q$  up to a closest distance  $r$  and then returns. If  $q$  were given a speed of  $2v$ , then closest distance of approach would be  
 (a)  $r$  (b)  $2r$  (c)  $r/2$  (d)  $\frac{r}{4}$
- 14** Figure below shows six equal capacitors each of capacitance  $C$  connected to each other.

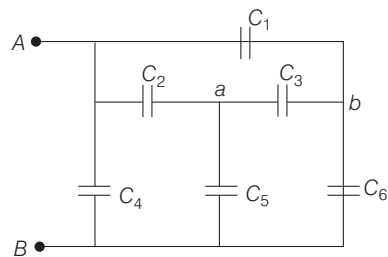

What will be the value of equivalent capacitance between A and B?

- (a)  $6C$  (b)  $C$   
 (c)  $2C$  (d)  $C/2$

- 15** In the given circuit diagram,  $E = 5 \text{ V}$ ,  $r = 1 \Omega$ ,  $R_2 = 4 \Omega$ ,  $R_1 = R_3 = 1 \Omega$  and  $C = 3 \mu\text{F}$ .

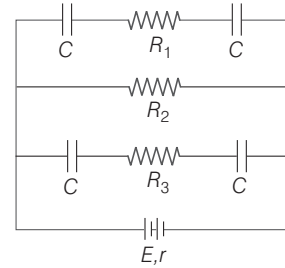

Then, what is the numerical value of the charge on each plate of the capacitor?

- (a)  $24 \mu\text{C}$  (b)  $12 \mu\text{C}$  (c)  $6 \mu\text{C}$  (d)  $3 \mu\text{C}$
- 16** Two cells of emfs approximately 5 V and 10 V are to be accurately compared using a potentiometer of length 400 cm.  
 (a) The battery that runs the potentiometer should have voltage of 8 V  
 (b) The battery of potentiometer can have a voltage of 15 V and  $R$  adjusted, so that the potential drop across the wire slightly exceeds 10 V  
 (c) The first portion of 50 cm of wire itself should have a potential drop of 10 V  
 (d) Potentiometer is usually used for comparing resistances and not voltages
- 17** A 500 W heating unit is designed to operate on a 115 V line. If the line voltage drops to 110 V line, the percentage drop in heat output will be  
 (a) 7.6% (b) 8.5% (c) 8.1% (d) 10.2%
- 18** A parallel plate capacitor is connected to a battery. The plates are pulled apart with a uniform speed. If  $x$  is the separation between the plates, the time rate of change of electrostatic energy of capacitor is proportional to  
 (a)  $x^{-2}$  (b)  $x$   
 (c)  $x^{-1}$  (d)  $x^2$
- 19** A 120 W, 60 V bulb is to be operated on a 120 V DC supply. For this a resistor of resistance  $R$  is connected in series with the bulb. The value of  $R$  is  
 (a)  $60 \Omega$   
 (b)  $30 \Omega$   
 (c)  $90 \Omega$   
 (d)  $100 \Omega$
- 20** Twenty identical bulbs are connected in series across a 220 V supply. Two of the bulbs are found to burn out. The remaining 18 bulbs are connected again in series across the same supply. The illumination will be  
 (a) the same in both the cases  
 (b) more with 20 bulbs than with 18 bulbs  
 (c) more with 18 bulbs than with 20 bulbs  
 (d) unpredictable as the given data is not sufficient

- 21** Five identical plates, each of area  $A$  are joined as shown in figure. The distance between the plates is  $d$ . The plates are connected to a potential difference  $V$  volt. The charge on plates 1 and 4 will be

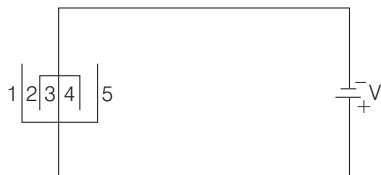

- (a)  $q$  and  $q$  (b)  $q$  and  $+2q$   
 (c)  $q$  and  $-2q$  (d)  $q$  and  $3q$
- 22** In a potentiometer experiment the balancing length with a cell is at length 240 cm. On shunting the cell with a resistance of  $2\ \Omega$ , the balancing length becomes 120 cm. The internal resistance of the cell is
- (a)  $4\ \Omega$  (b)  $2\ \Omega$   
 (c)  $1\ \Omega$  (d)  $0.5\ \Omega$
- 23** Electric bulbs 50 W-100 V glowing at full power are to be used in parallel with battery 120 V,  $10\ \Omega$ . Maximum number of bulbs that can be connected, so that they glow in full power is
- (a) 2 (b) 8  
 (c) 4 (d) 6
- 24** Masses of 3 wires of same metal are in the ratio  $1 : 2 : 3$  and their lengths are in the ratio  $3 : 2 : 1$ . The electrical resistances are in ratio
- (a)  $1 : 4 : 9$  (b)  $9 : 4 : 1$   
 (c)  $1 : 2 : 3$  (d)  $27 : 6 : 1$
- 25** A uniform resistance wire of length  $L$  and diameter  $d$  has a resistance  $R$ . Another wire of same material has length  $4L$  and diameter  $2d$ , the resistance will be
- (a)  $2R$  (b)  $R$   
 (c)  $R/2$  (d)  $R/4$

**Direction** (Q. Nos. 26-31) In each of the following questions, a statement of Assertion is given followed by a corresponding statement of Reason just below it. Of the statements, mark the correct answer as

- (a) If both Assertion and Reason are true and Reason is the correct explanation of Assertion  
 (b) If both Assertion and Reason are true but Reason is not the correct explanation of Assertion  
 (c) If Assertion true but Reason is false  
 (d) If both Assertion and Reason are false
- 26 Assertion** (A) A parallel plate capacitor is connected across battery through a key. A dielectric slab of dielectric constant  $K$  is introduced between the plates. The energy which is stored becomes  $K$  times.

**Reason** (R) The surface density of charge on the plate remains constant or unchanged.

- 27 Assertion** (A) If the distance between parallel plates of a capacitor is halved and dielectric constant becomes three times, then the capacitance becomes 6 times.

**Reason** (R) Capacity of the capacitor does not depend upon the nature of the material.

- 28 Assertion** (A) When an insulated wire is bent, its resistivity increases.

**Reason** (R) On bending, the drift velocity of electron decreases.

- 29 Assertion** (A) An electric bulb becomes dim, when an electric heater in parallel circuit is switched on.

**Reason** (R) Dimness decreases after some time.

- 30 Assertion** (A) The power dissipated in a conductor of resistivity  $\rho$  is proportional to  $\rho^{-1}$ .

**Reason** (R) The expression for resistance of a conductor is given by  $R = \frac{\rho l}{A}$ .

- 31 Assertion** (A) A thermoelectric refrigerator is based on the Peltier effect.

**Reason** (R) A thermocouple may be used as a radiation detector.

- 32** A spherical drop of capacitance  $1\ \mu\text{F}$  is broken into eight drops of equal radius. Then, the capacitance of each small drop is

- (a)  $\frac{1}{2}\ \mu\text{F}$  (b)  $\frac{1}{4}\ \mu\text{F}$  (c)  $\frac{1}{8}\ \mu\text{F}$  (d)  $8\ \mu\text{F}$

- 33** A parallel plate capacitor filled with a material of dielectric constant  $K$  is charged to a certain voltage. The dielectric material is removed. Then,

- the capacitance decreases by a factor  $K$
- the electric field reduces by a factor  $K$
- the voltage across the capacitor increases by a factor  $K$
- the charge stored in the capacitor increases by a factor  $K$

- (a) 1 and 2 are true (b) 1 and 3 are true  
 (c) 2 and 3 are true (d) 2 and 4 are true

- 34** The capacity of a condenser is  $4 \times 10^{-6}\ \text{F}$  and its potential is 100 V. The energy released on discharging it fully will be

- (a) 0.04 J (b) 0.02 J (c) 0.025 J (d) 0.05 J

- 35** A parallel plate capacitor having a plate separation of 2 mm is charged by connecting it to a 300 V supply. The energy density is

- (a)  $0.01\ \text{Jm}^{-3}$  (b)  $0.1\ \text{Jm}^{-3}$  (c)  $1.0\ \text{Jm}^{-3}$  (d)  $10\ \text{Jm}^{-3}$

- 36** The capacity of an air condenser is  $2.0\ \mu\text{F}$ . If a medium is placed between its plates. The capacity becomes  $12\ \mu\text{F}$ . The dielectric constant of the medium will be

- (a) 5 (b) 4 (c) 3 (d) 6

**37** The capacitors  $A$  and  $B$  have identical geometry. A material with a dielectric constant 3 is present between the plates of  $B$ . The potential difference across  $A$  and  $B$  are respectively

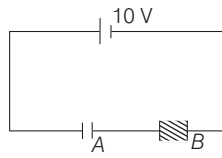

- (a) 2.5 V, 7.5 V (b) 2 V, 8 V (c) 8 V, 2 V (d) 7.5 V, 2.5 V

**38** Between the plates of parallel plate capacitor of capacity  $C$ , two parallel plates of the same material and area same as the plate of the original capacitor, are placed. If the thickness of these plates is equal to  $1/5$ th of the distance between the plates of the original capacitor, then the capacity of the new capacitor is

- (a)  $\frac{5}{3}C$  (b)  $\frac{3}{5}C$  (c)  $\frac{3C}{10}$  (d)  $\frac{10C}{3}$

**39** A wire has linear resistance  $\rho$  (in  $\Omega\text{m}^{-1}$ ). Find the resistance  $R$  between points  $A$  and  $B$ , if the side of the big square is  $d$

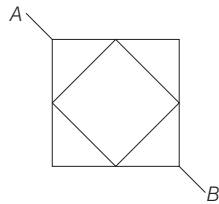

- (a)  $\frac{\rho d}{\sqrt{2}}$  (b)  $\sqrt{2} \rho d$   
 (c)  $2\rho d$  (d) None of these

**40** The equivalent resistance between the points  $P$  and  $Q$  in the network given here is equal to  $R$ .

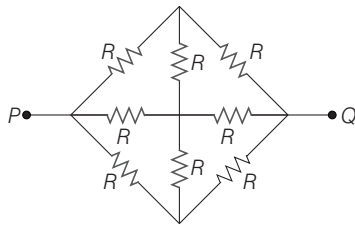

- (a)  $R$  (b)  $\frac{2R}{3}$  (c)  $2R$  (d)  $\frac{R}{2}$

**41** For the potentiometer arrangement as shown in the figure, length of wire  $AB$  is 100 cm and its resistance is  $9 \Omega$ . Find the length  $AC$  for which the galvanometer  $G$  will show zero deflection.

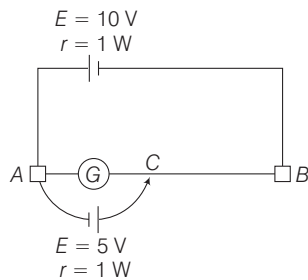

- (a) 66.7 cm (b) 60 cm (c) 50 cm (d) 33.3 cm

**42** In a practical Wheatstone bridge circuit, when one more resistance of  $100 \Omega$  is connected in parallel with unknown resistance  $x$ , then the ratio  $l_1/l_2$  becomes 2.  $l_1$  is the balance length.  $AB$  is a uniform wire. Then, the value of  $x$  must be

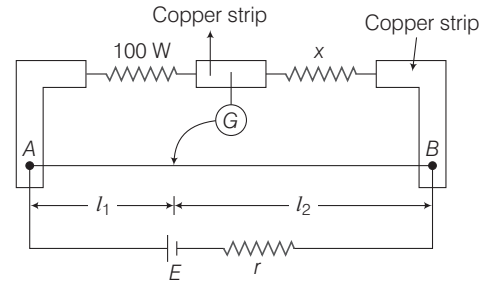

- (a)  $50 \Omega$  (b)  $100 \Omega$  (c)  $200 \Omega$  (d)  $400 \Omega$

**43** In the circuit given, the points  $A$ ,  $B$  and  $C$  are 70V, zero and 10V respectively. Then,

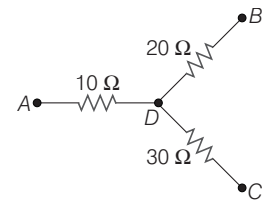

- (a) The point  $D$  will be at a potential of 60V  
 (b) The point  $D$  will be at a potential of 20V  
 (c) Currents in the paths  $AD$ ,  $DB$  and  $DC$  are in the ratio of 1 : 2 : 3  
 (d) Current in the paths  $AD$ ,  $DB$  and  $DC$  are in the ratio of 3 : 2 : 1

**44** For the circuit shown, a shorting wire of negligible resistance is added to the circuit between points  $A$  and  $B$ . When this shorting wire is added, bulb 3 goes out. Which bulbs (all identical) in the circuit are brighter?

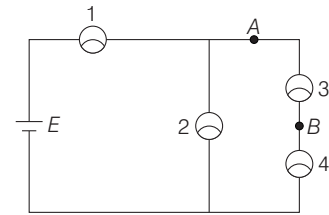

- (a) Only bulb 2 (b) Only bulb 4  
 (c) Bulbs 1 and 4 (d) Bulbs 2 and 4

**45** A charged ball of mass 9 kg is suspended from a string in a uniform electric field  $\mathbf{E} = (3\mathbf{i} + 5\mathbf{j}) \times 10^5 \text{ N/C}$ . The ball is in equilibrium with  $\theta = 37^\circ$ . If direction of electric field is reversed, find the new equilibrium position of the ball. Give your answer in terms of angle made by string with vertical (Take,  $g = 10 \text{ ms}^{-2}$ ).

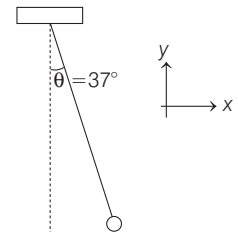

- (a)  $\tan^{-1}\left(\frac{3}{4}\right)$  (b)  $\cot^{-1}\left(\frac{3}{14}\right)$   
 (c)  $\cot^{-1}\left(\frac{3}{4}\right)$  (d)  $\tan^{-1}\left(\frac{3}{14}\right)$

- 46** Three infinite planes have a uniform surface charge distribution  $\sigma$  on its surface. All charges are fixed. On each of the three infinite planes, parallel to the  $yz$ -plane placed at  $x = -a$ ,  $x = 0$ , and  $x = a$ , there is a uniform surface charge of the same density,  $\sigma$ . The potential difference between A and C is

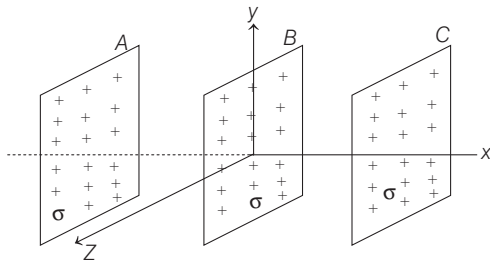

- (a)  $\frac{2\sigma}{\epsilon_0} a$                       (b)  $\frac{\sigma}{\epsilon_0} a$   
 (c)  $\frac{\sigma a}{2\epsilon_0}$                          (d) None of these

- 47** In the given arrangement of capacitors,  $6 \mu\text{F}$  charge is added to point a. Find the charge on upper capacitor

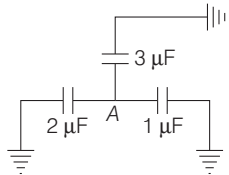

- (a)  $3 \mu\text{C}$                                       (b)  $1 \mu\text{C}$   
 (c)  $2 \mu\text{C}$                                       (d)  $6 \mu\text{C}$

- 48** One-fourth of a sphere of radius  $R$  is removed as shown in figure. An electric field  $E$  exists parallel to the  $xy$ -plane. Find the flux through the remaining curved part.

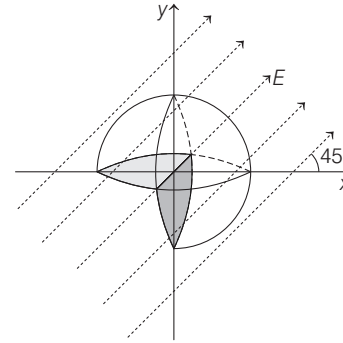

- (a)  $\pi R^2 E$   
 (b)  $\sqrt{2} \pi R^2 E$   
 (c)  $\pi R^2 E / \sqrt{2}$   
 (d) None of the above

- 49** A hollow cylinder has a charge  $q$  coulomb within it. If  $\phi$  be the electric flux in units of voltmeter associated with the curved surface B, the flux linked with the plane surface A in units of voltmeter will be

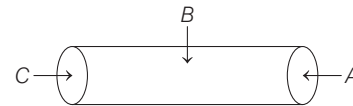

- (a)  $\frac{1}{2} \left( \frac{q}{\epsilon_0} - \phi \right)$     (b)  $\frac{q}{2\epsilon_0}$     (c)  $\frac{\phi}{3}$     (d)  $\frac{q}{\epsilon_0} - \phi$

## ANSWERS

- |         |         |         |         |         |         |         |         |         |         |
|---------|---------|---------|---------|---------|---------|---------|---------|---------|---------|
| 1. (b)  | 2. (a)  | 3. (c)  | 4. (c)  | 5. (d)  | 6. (b)  | 7. (c)  | 8. (d)  | 9. (a)  | 10. (a) |
| 11. (c) | 12. (b) | 13. (d) | 14. (c) | 15. (c) | 16. (b) | 17. (b) | 18. (a) | 19. (b) | 20. (c) |
| 21. (c) | 22. (b) | 23. (c) | 24. (d) | 25. (b) | 26. (c) | 27. (b) | 28. (d) | 29. (b) | 30. (a) |
| 31. (b) | 32. (a) | 33. (b) | 34. (b) | 35. (b) | 36. (d) | 37. (d) | 38. (a) | 39. (a) | 40. (b) |
| 41. (a) | 42. (b) | 43. (d) | 44. (c) | 45. (d) | 46. (d) | 47. (a) | 48. (c) | 49. (a) |         |

# Hints and Explanations

- 1** Current through the branch  $CDA = 1$  A towards A.

Applying KVL to the mesh  $ACDA$ ,

$$1 \times 5 - 1 \times R = E + 1$$

$$5 - 1 \times 1 = E + 1$$

$$\therefore E = 3 \text{ V}$$

- 2** When two cells of emf's  $E_1$  and  $E_2$  and internal resistances  $r_1$  and  $r_2$ , respectively are connected in parallel and across an external resistance  $R$  as shown in the figure, it can be proved that

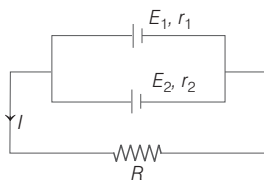

$$I = \frac{E_1/r_1 + E_2/r_2}{1 + R\left(\frac{1}{r_1} + \frac{1}{r_2}\right)}$$

Now,  $E_1 = 3 \text{ V}$ ,  $r_1 = 1 \ \Omega$ ,  $E_2 = 2 \text{ V}$ ,  $r_2 = 2 \ \Omega$ ,  $R = 5 \ \Omega$

$$\therefore I = \frac{\frac{3}{1} + \frac{2}{2}}{1 + 5\left(\frac{1}{1} + \frac{1}{2}\right)} = \frac{4}{1 + 15/2} = \frac{8}{17} \text{ A}$$

Potential difference across  $5 \ \Omega$  resistor

$$= \frac{8}{17} \times 5 = \frac{40}{17} = 2.4 \text{ V}$$

- 3**  $P = 2.5 \ \Omega$ ,  $Q = 5 \ \Omega$ ,  $R = 10 \ \Omega$ ,

$$S = 40x/(40 + x)$$

For balance,  $\frac{P}{Q} = \frac{R}{S}$

$$\text{i.e. } \frac{2.5}{5} = \frac{10}{40x} (40 + x)$$

$$\text{i.e. } \frac{1}{2} = \frac{40 + x}{4x}, 2x = 40 + x, x = 40 \ \Omega$$

- 4** Electric field at point on the axis of symmetry of a circular loop at a distance  $x$  from the centre of loop is

$$E = \frac{kqx}{(r^2 + x^2)^{3/2}}$$

Substituting,  $k = 9 \times 10^9 \text{ N}\cdot\text{m}^2\text{C}^{-2}$ ;

$$q = 4 \ \mu\text{C} = 4 \times 10^{-6}\text{C};$$

$$r = 6 \text{ cm} = 6 \times 10^{-2}\text{m}$$

$$x = 8 \text{ cm} = 8 \times 10^{-2}\text{m}, \text{ we get}$$

$$\therefore E = 288 \times 10^4 \text{ Vm}^{-1}$$

- 5** Dipole consists of equal and opposite charges. Here, the net charge enclosed is zero.

- 6** The current density is a vector quantity. Its direction is given by the direction of flow of positive charge in the circuit. The same is possible due to electric field produced by charges accumulated on the surface of wire.

- 7**  $R = \frac{\rho l}{A} = \frac{\rho l}{\pi r^2}$ . Given,  $\rho_A = 2\rho_B$ , while  $l$  and  $r$  have the same value.

$$\therefore R_A = 2R_B, \text{ i.e. } R_A > R_B$$

$$\therefore P = \frac{V^2}{R} \Rightarrow P_A < P_B$$

- 8** Magnitude of electric field is given by

$$E = -\frac{dV}{dr}$$

Substituting,  $V = -5x + 3y + \sqrt{15}z$ , we get

$$E_x = -5; E_y = 3; E_z = \sqrt{15}$$

$$\text{Now, } E = (E_x^2 + E_y^2 + E_z^2)^{1/2} = 7$$

- 9** Here, radius of drops =  $1 \text{ mm} = 10^{-3} \text{ m}$

$$\text{Charge} = 0.066 \text{ pC} = 0.066 \times 10^{-12} \text{ C}$$

Potential,

$$V = \frac{1}{4\pi\epsilon_0} \frac{q}{r} = 9 \times 10^9 \times \frac{0.066 \times 10^{-12}}{10^{-3}}$$

Potential of bigger drop =  $n^{2/3} \times$   
potential of small drops

$$= (8)^{2/3} \times 9 \times 10^9 \times \frac{0.066 \times 10^{-12}}{10^{-3}}$$

$$= 2.4 \text{ V}$$

- 10** We know that,  $\Delta W = \frac{kq_1 q_2}{r}$

Here,  $q_1 = 40 \times 10^{-9}\text{C}$

$$\text{Charge on sphere, } q_2 = \frac{4}{3} \pi r^3 \rho$$

$$r = 2 \text{ cm}, \rho = 10^{-4} \text{ C cm}^{-3}$$

Putting the values, we get

$$\text{Work done} = 14.4 \ \pi$$

- 11** Thickness =  $\frac{V}{A} = \frac{m}{dA} = \frac{ZI}{dA}$
- $$= \frac{3.3 \times 10^{-7} \times 1.5 \times 20 \times 60}{50 \times 10^{-4} \times 9000}$$
- $$= 1.3 \times 10^{-5} \text{ m}$$

- 12** Since, the surface charge densities of both the concentric spheres are equal

$$\Rightarrow \sigma = \frac{q_1}{4\pi r^2} = \frac{q_2}{4\pi R^2}$$

$$\Rightarrow \text{and } \left. \begin{aligned} q_1 &= 4\pi r^2 \sigma \\ q_2 &= 4\pi R^2 \sigma \end{aligned} \right\} \dots(\text{i})$$

Now, total charge on the spheres is given by

$$Q = q_1 + q_2 = 4\pi r^2 \sigma + 4\pi R^2 \sigma$$

[using Eq. (i)]

$$\text{or } Q = 4\pi (r^2 + R^2) \sigma \dots(\text{ii})$$

$$\Rightarrow \sigma = \frac{Q}{4\pi (r^2 + R^2)}$$

Now, total potential due to both concentric spheres is given by

$$V = \frac{1}{4\pi\epsilon_0} \frac{q_1}{r} + \frac{1}{4\pi\epsilon_0} \frac{q_2}{R}$$

$$\text{or } V = \frac{1}{4\pi\epsilon_0} \left[ \frac{q_1}{r} + \frac{q_2}{R} \right]$$

$$\text{or } V = \frac{1}{4\pi\epsilon_0} \left[ \frac{4\pi r^2 \sigma}{r} + \frac{4\pi R^2 \sigma}{R} \right]$$

[using Eq. (i)]

$$\text{or } V = \frac{\sigma}{\epsilon_0} (R + r)$$

$$\text{or } V = \frac{1}{4\pi\epsilon_0} \frac{Q(R + r)}{R^2 + r^2} \text{ [using Eq. (ii)]}$$

$$\Rightarrow V = \frac{kQ(R + r)}{R^2 + r^2} \text{ [using Eq. (ii)]}$$

- 13** From principle of conservation of energy, we have

Kinetic energy = Electrostatic potential energy, i.e.

$$\frac{1}{2} mv^2 = \frac{KqQ}{r} \dots(\text{i})$$

When the speed of charge  $q$  is doubled, then we have  $\frac{1}{2} m(2v)^2 = \frac{KqQ}{r'}$  ... (ii)

On dividing Eq. (i) by Eq. (ii), we get

$$\frac{1}{4} = \frac{r'}{r} \Rightarrow r' = \frac{r}{4}$$

- 14**  $C_4$  is in parallel to a balanced Wheatstone bridge made from the rest five capacitors as shown in the figure. Therefore, equivalent capacitance

$$= C + C = 2C$$

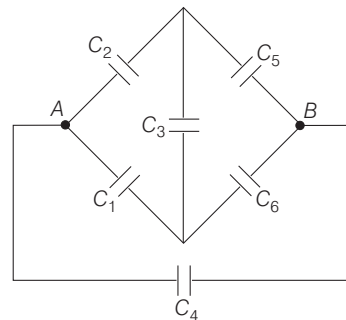

15 Current will flow only through the branch containing resistance  $R_2$ .

$$\therefore I = \frac{E}{R_2 + r} = \frac{5}{4 + 1} = 1 \text{ A}$$

Potential difference across  $R_2 = 1 \times 4 = 4 \text{ V}$

If  $q$  be the charge on each plate of the capacitor, then

$$\frac{q}{C} + \frac{q}{C} = 4 \text{ or } \frac{2q}{C} = 4$$

or  $\frac{2q}{3 \times 10^{-6}} = 4 \text{ or } q = 6 \mu\text{C}$

16 In a potentiometer experiment, the emf of a cell can be measured, if the potential drop along the potentiometer wire is more than the emf of the cell to be determined. As values of emf's of two cells are approximately 5 V and 10 V, therefore the potential drop along the potentiometer wire must be more than 10 V. Hence, option (b) is correct.

$$17 R = \frac{V^2}{P} = \frac{(115)^2}{500} \Omega$$

Percentage drop in heat output when voltage drops 110 V

$$= \frac{500 - \frac{110 \times 110}{500} \times 500}{500} \times 100 = 8.5\%$$

18 Energy of a parallel plate capacitor is given by

$$U = \frac{1}{2} CV^2 = \frac{1}{2} \left( \frac{\epsilon_0 A}{d} \right) V^2$$

Given that,  $d = x$

$$\text{Therefore, we have } U = \frac{1}{2} \left( \frac{\epsilon_0 A}{x} \right) V^2$$

$$\text{Therefore, } \frac{dU}{dt} = \frac{1}{2} \epsilon_0 AV^2 (-1) \frac{1}{x^2} \frac{dx}{dt}$$

$$\text{or } \frac{dU}{dt} = -\frac{1}{2} \frac{\epsilon_0 AV^2}{x^2} (v)$$

Potential energy decreases as

$$= -\frac{1}{2} \frac{\epsilon_0 AV^2}{x^2} (v)$$

$$\Rightarrow \frac{dU}{dt} \propto x^{-2}$$

19 Resistance of the bulb is

$$R_1 = V^2 / P = 60 \times 60 / 120 = 30 \Omega$$

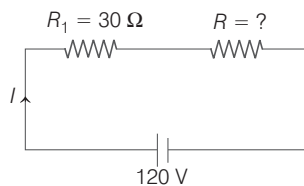

Current through the bulb is

$$I = P / V = 120 / 60 = 2 \text{ A}$$

$$I = \frac{120}{R + R_1} = 2, R + R_1 = 60$$

$$R = 60 - R_1 = 60 - 30 = 30 \Omega$$

20 The bulbs are in series. When two of the bulbs burn out and the remaining 18 are connected in series, the effective resistance will be reduced. As a result, a higher current flows through the combination. Hence, the illumination will be more with 18 bulbs than with 20 bulbs.

21 The equivalent circuit of given network is given as,

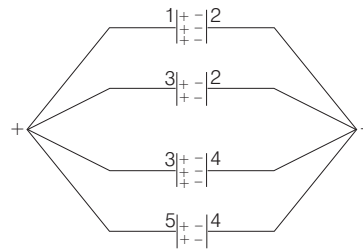

Each capacitor has a value

$$\text{i.e. } C = \frac{\epsilon_0 A}{d}$$

The equivalent capacitance of the circuit is

$$4C = 4\epsilon_0 A / d$$

Thus, the charge on the combination will be

$$4q = 4\epsilon_0 AV / d$$

In parallel connection total charge is divided in the ratio of capacitances. Therefore, charge on first plate is  $q$  and fourth plate is  $-2q$ .

$$22 \text{ Here, } r = \frac{l_1 - l_2}{l_2} \times 2 \Omega$$

where,  $l_1 = 240 \text{ cm}$ ,  $l_2 = 120 \text{ cm}$

$$\text{So, } r = \frac{240 - 120}{120} \times 2$$

$$\text{or } r = \frac{120}{120} \times 2 = 2 \Omega$$

23 Potential drop across battery,  $V = 20 \text{ V}$

Thus, current from the battery,

$$I = \frac{V}{R} = \frac{20}{10} = 2 \text{ A}$$

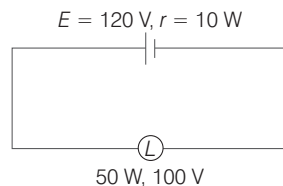

Current through each lamp is given by

$$I_L = \frac{P}{V_1} = \frac{50}{100} \Rightarrow I_L = 0.5 \text{ A}$$

Since, total current from battery is 2 A and each lamp requires 0.5 A, therefore maximum 4 lamps can be connected.

24 Resistance of wire in terms of length and area of cross-section is given by

$$R = \rho \frac{l}{A}$$

Since, volume =  $\frac{\text{mass}}{\text{density}}$  and

$$\text{Area} = \frac{\text{Volume}}{\text{Length}}$$

$$\text{Thus, } R = \rho \frac{l^2}{M}$$

$$\Rightarrow R_1 : R_2 : R_3 = \frac{l_1^2}{M_1} : \frac{l_2^2}{M_2} : \frac{l_3^2}{M_3}$$

Here,  $M_1 : M_2 : M_3 = 1 : 2 : 3$

and  $l_1 : l_2 : l_3 = 3 : 2 : 1$

$$\Rightarrow R_1 : R_2 : R_3 = 27 : 6 : 1$$

25 Resistance of wire of length  $L$  and diameter  $d$  is given by

$$R = \rho \frac{L}{\pi (d/2)^2} \text{ or } R = \frac{4 \rho L}{\pi d^2}$$

Now, resistance when length is  $4L$  and diameter  $2d$  will be

$$R' = \frac{\rho 4L}{\pi \left( \frac{2d}{2} \right)^2}$$

$$\text{or } R' = \frac{\rho (4L)}{\pi d^2}$$

$$\Rightarrow R' = R = \frac{4 \rho L}{\pi d^2}$$

26 If a dielectric slab of dielectric constant  $K$  is filled in between the plates of a condenser while charging it, the potential difference between the plates does not change, but the capacity becomes  $K$  times. Therefore,

$$V' = V, C' = KC$$

$\therefore$  Energy stored in the capacitor,

$$U' = \frac{1}{2} C' V'^2 = \frac{1}{2} (KC) (V^2)$$

$$= \left( \frac{1}{2} CV^2 \right) K = KU$$

Thus, energy stored becomes  $K$  times.

Surface charge density,

$$\sigma' = \frac{q'}{A} = \frac{C' V'}{A} = \frac{KC V}{A} = K \frac{q}{A} = K \sigma$$

27 The capacitance of a capacitor,

$$C = \frac{K \epsilon_0 A}{d} \propto \frac{K}{d}$$

$$\text{Hence, } \frac{C_1}{C_2} = \frac{K_1}{d_1} \times \frac{d_2}{K_2} = \frac{K_1}{K_2} \times \frac{d/2}{3K} = \frac{1}{6}$$

$$\text{or } C_2 = 6 C_1$$

Again, capacity of a capacitor  $C = \frac{Q}{V}$

Therefore, capacity of a capacitor does not depend upon the nature of the material.

**28** Resistivity or specific resistance is a material property. So, it does not change on bending the insulated wire. On bending, the cross-sectional area of wire changes but drift velocity of electron does not depend on area of cross-section, so it does not change.

**29** The electric power of a heater is more than that of a bulb. As  $P \propto \frac{1}{R}$ , the

resistance of heater is less than that of the electric bulb. When a heater connected in parallel to the bulb is switched on, it draws more current due to its lesser resistance, consequently, the current through the bulb decreases and so it becomes dim.

When the heater coil becomes sufficiently hot, its resistance becomes more and then it draws a little lesser current. Consequently, the current through the electric bulb recovers.

Hence, dimness of the bulb decreases.

**30** From the formula,

$$P = \frac{V^2}{R} \quad \dots(i)$$

But  $R = \frac{\rho l}{A} \quad \dots(ii)$

Now, from Eqs. (i) and (ii), we have

$$P = \frac{V^2}{\frac{\rho l}{A}} = \frac{V^2 A}{\rho l} \Rightarrow P \propto \frac{1}{\rho}$$

$$\Rightarrow P \propto \rho^{-1}$$

**31** A thermocouple, which is also called thermoelectric detector can be used to detect heat radiations. It is also true that working of thermoelectric refrigerator is based on the Peltier effect.

**32** Let  $R$  and  $r$  be the radii of bigger and each smaller drop, respectively.

$$\therefore \frac{4}{3} \pi R^3 = 8 \times \frac{4}{3} \pi r^3$$

$$\Rightarrow R = 2r \quad \dots(i)$$

The capacitance of a smaller spherical drop is

$$C = 4 \pi \epsilon_0 r \quad \dots(ii)$$

The capacitance of bigger drop is

$$C' = 4 \pi \epsilon_0 R = 2 \times 4 \pi \epsilon_0 r$$

[ $\because R = 2r$ ]

$$= 2C \quad [\text{from Eq. (ii)}]$$

$$\therefore C = \frac{C'}{2} = \frac{1}{2} \mu\text{F} \quad [\because C' = 1 \mu\text{F}]$$

**33** As capacitance of capacitor after introducing dielectric is given by

$$C = \frac{K \epsilon_0 A}{d}$$

Here, if dielectric is introduced the capacitance increases by  $K$ , but when dielectric is removed, then capacitance

will decrease by factor  $K$  and since,

$$V = \frac{Q}{C}$$

Hence, if  $C$  decreases by factor  $K$ , then  $V$  will increase by factor  $K$ .

**34** Energy

$$E = \frac{1}{2} CV^2 = \frac{1}{2} \times 4 \times 10^{-6} \times (100)^2$$

$$= 2 \times 10^{-2} = 0.02 \text{ J}$$

**35** The energy per unit volume or the energy density is given by

$$U = \frac{1}{2} \epsilon_0 E^2 \quad \dots(i)$$

where,  $\epsilon_0$  is permittivity of free space and  $E$  is electric field.

Also,

$$E = \frac{\text{Potential difference}}{\text{Distance between the plates}} = \frac{V}{d} \quad \dots(ii)$$

From Eqs. (i) and (ii), we have

$$U = \frac{1}{2} \epsilon_0 \left( \frac{V}{d} \right)^2$$

Given,  $V = 300 \text{ V}$ ,  $d = 2 \text{ mm}$

$$= 2 \times 10^{-3} \text{ m},$$

$$\epsilon_0 = 8.85 \times 10^{-12} \text{ C}^2 \text{N}^{-1} \text{m}^{-2}$$

$$U = \frac{1}{2} \times 8.85 \times 10^{-12} \times \left( \frac{300}{2 \times 10^{-3}} \right)^2$$

$$= 0.1 \text{ Jm}^{-3}$$

**36** Dielectric constant of medium  $K = \frac{\text{Capacity of condenser with medium}}{\text{Capacity of condenser}}$

$$= \frac{12}{2.0} = 6$$

**37** Let  $q$  be charge in the series circuit and  $C$  be the capacitance across  $A$  and  $C'$  across  $B$ . Then,

$$C = \frac{\epsilon_0 A}{d}, C' = \frac{K \epsilon_0 A}{d}$$

Also,  $q = CV$

Let  $V_1, V_2$  be potential across  $A$  and  $B$ , respectively. Then,

$$V = V_1 + V_2 = 10 \text{ V}$$

where,  $V_1 = \frac{q}{C}, V_2 = \frac{q}{KC} = \frac{q}{3C}$

$$\therefore \frac{q}{C} + \frac{q}{3C} = 10$$

$$\frac{q}{C} \left[ 1 + \frac{1}{3} \right] = 10$$

$$\frac{q}{C} \times \frac{4}{3} = 10$$

$$\Rightarrow \frac{q}{C} = \frac{30}{4} = 7.5 \text{ V}$$

and  $V_2 = 10 - 7.5 = 2.5 \text{ V}$

**38** Thickness of each plates =  $\frac{1}{5}$  distance between plates

$$= \frac{1}{5} \times d$$

The capacitance of capacitor is given by

$$C_1 = \frac{\epsilon_0 A}{d - t} \quad \dots(i)$$

Thickness of two conductor is given by

$$t = 2 \left( \frac{d}{5} \right) = \frac{2d}{5}$$

On putting the values of  $t$  in Eq. (i), we get

$$C_1 = \frac{\epsilon_0 A}{d - \frac{2d}{5}} = \frac{5 \epsilon_0 A}{3 d}$$

$$= \frac{5}{3} C \quad \left[ \text{where, } C = \frac{\epsilon_0 A}{d} \right]$$

**39** The circuit is equivalent to

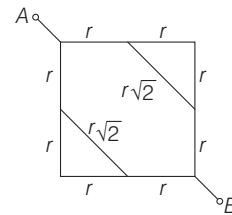

Let each half side has resistance  $r = \rho \frac{d}{2}$ .

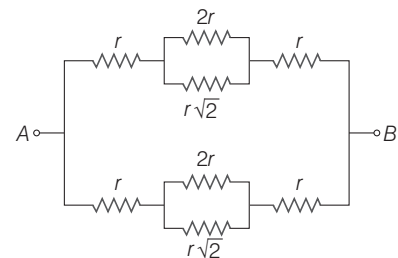

On solving, we get

$$R = \frac{1}{2} \left[ 2r + \frac{(2r)(r\sqrt{2})}{(2 + \sqrt{2})r} \right] = r\sqrt{2}$$

$$= \frac{\rho d}{\sqrt{2}}$$

**40** The given circuit can be simplified as

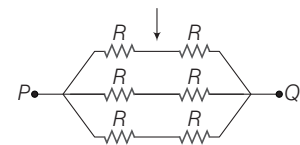
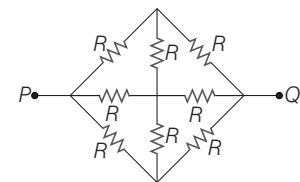

$$\Rightarrow \frac{1}{R_{\text{eq}}} = \frac{1}{2R} + \frac{1}{2R} + \frac{1}{2R}$$

$$\Rightarrow R_{\text{eq}} = \frac{2R}{3}$$



**41** Potential difference across AC is zero.

$$5 - 2I = 0$$

or  $I = 2.5 \text{ A}$

Let the resistance of part BC be  $r$ .

Applying KVL, we get

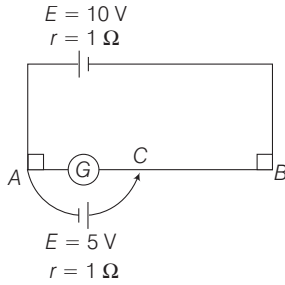

$$10 + 5 - 2I - Ir - I = 0$$

or  $2.5r = 7.5$  or  $r = 3 \Omega$

As resistance of part AB =  $9 \Omega$ , length AC =  $66.7 \text{ cm}$

**42** The Wheatstone bridge is in balanced conditions, so

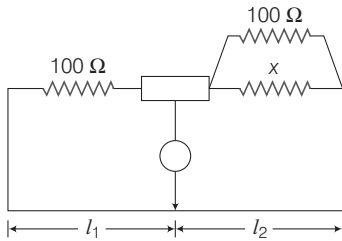

$$\frac{100x}{l_1} = \frac{100 + x}{l_2}$$

$\therefore \frac{l_1}{l_2} = 2$  or  $x = 100 \Omega$

**43** At point D apply KCL,

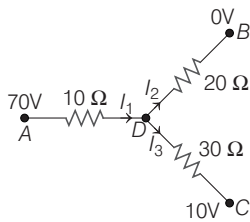

$$\Rightarrow \frac{I_1 = I_2 + I_3}{\frac{V_A - V_D}{10} = \frac{V_D - V_B}{20} + \frac{V_D - V_C}{30}}$$

$$\Rightarrow 70 - V_D = \frac{V_D}{2} + \frac{V_D - 10}{3}$$

$$\Rightarrow V_D = 40V$$

$$I_1 = \frac{V_A - V_D}{10} = \frac{70 - 40}{10} = 3A$$

$$I_2 = \frac{V_D - V_B}{20} = \frac{40 - 0}{20} = 2A$$

$$I_3 = \frac{V_D - V_C}{30} = \frac{40 - 10}{30} = 1A$$

**44** Initially,  $R_{eq} = 5R/3$ . Finally,

$$R_{eq} = 3R/2$$

Equivalent resistance decreases, so current increases in circuit and in 1 also. Hence, brightness of 1 increases. It means potential difference across 1 increases, so across 2 potential difference decreases, hence brightness of 2 decreases.

Initially, potential difference across 4 is

$$V_{4i} = \frac{1}{2} \left[ \frac{(2R/3)E}{2R/3 + R} \right] = \frac{E}{5}$$

Finally,  $V_{4f} = \frac{(R/2)E}{R/2 + R} = \frac{E}{3}$

Since,  $V_{4f} > V_{4i}$ ; hence, brightness of 4 increases.

**45**

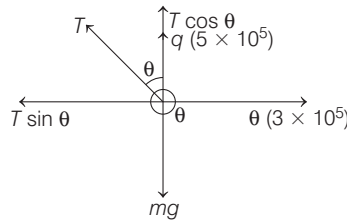

$$T \sin \theta = 3q \times 10^5 \quad \dots(i)$$

$$T \cos \theta = mg - 5q \times 10^5 \quad \dots(ii)$$

On solving, we get  $q = 100 \mu\text{C}$ ,  $T = 50 \text{ N}$   
After the reversal of direction of electric field,

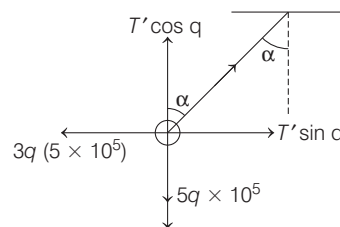

$$T' \sin \alpha = 3q \times 10^5$$

or  $T' \cos \alpha = mg + 5q \times 10^5$

$$\tan \alpha = \frac{3q \times 10^5}{mg + 5q \times 10^5}$$

$$= \frac{3 \times 10^{-4} \times 10^5}{9 \times 10 + 5 \times 10^{-4} \times 10^5} = \frac{3}{14}$$

or  $\alpha = \tan^{-1} \left( \frac{3}{14} \right)$

**46** Potential difference

$$\Delta V = - \int_A^B \mathbf{E} \cdot d\mathbf{l} = \text{zero}$$

**47**  $\frac{q_1}{1} = \frac{q_2}{2} = \frac{q_3}{3} = K$

$$q_1 + q_2 + q_3 = 6$$

Solving, we get

[ $\because K = 1$ ]

or  $q_3 = 3 \mu\text{C}$

**48**  $\phi_{\text{plane}} + \phi_{\text{curve}} = 0$  or  $\phi_{\text{plane}} = -\phi_{\text{curve}}$

$$\mathbf{A}_1 = -\frac{\pi R^2}{2} \hat{i}, \mathbf{A}_2 = -\frac{\pi R^2}{2} \hat{i}$$

$$\mathbf{E} = E \cos 45^\circ \hat{i} + E \sin 45^\circ \hat{j}$$

$$= \frac{E}{\sqrt{2}} \hat{i} + \frac{E}{\sqrt{2}} \hat{j}$$

$$\phi = \mathbf{E} \cdot (\mathbf{A}_1 + \mathbf{A}_2)$$

$$= \frac{-E \pi R^2}{\sqrt{2}} - \frac{E \pi R^2}{\sqrt{2}} = \frac{-\pi R^2 E}{\sqrt{2}}$$

This is the flux entering. So, flux is  $\frac{\pi R^2 E}{\sqrt{2}}$

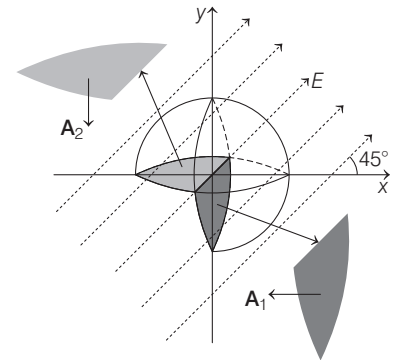

**49**  $\phi_{\text{total}} = \phi_A + \phi_B + \phi_C = \frac{q}{\epsilon_0}$

As,  $\phi_B = \phi$

Let  $\phi_A = \phi_C = \phi'$ , then

$$2\phi' + \phi = \frac{q}{\epsilon_0} \Rightarrow \phi' = \frac{1}{2} \left( \frac{q}{\epsilon_0} - \phi \right)$$